



# VCU

Virginia Commonwealth University  
VCU Scholars Compass

---

Theses and Dissertations

Graduate School

---

2018

## tRNA Profiling of Mesenchymal Stem Cell Exosome

Khin MiMi San

*Department of Periodontics, School of Dentistry, Virginia Commonwealth University*

Follow this and additional works at: <https://scholarscompass.vcu.edu/etd>



Part of the [Periodontics and Periodontology Commons](#)

© The Author

---

Downloaded from

<https://scholarscompass.vcu.edu/etd/5638>

This Thesis is brought to you for free and open access by the Graduate School at VCU Scholars Compass. It has been accepted for inclusion in Theses and Dissertations by an authorized administrator of VCU Scholars Compass. For more information, please contact [libcompass@vcu.edu](mailto:libcompass@vcu.edu).

Copyright Khin MiMi San 2018  
All Rights Reserved

## **tRNA Profiling of Mesenchymal Stem Cell Exosome**

A thesis submitted in partial fulfillment of the requirements for  
the degree of a Master of Science in Dentistry at Virginia  
Commonwealth University

By

Khin MiMi San

University of Pretoria, South Africa, 2011

Director: Zhao Lin

Assistant Professor, Department of Periodontics

Graduate Periodontics

Virginia Commonwealth University

Richmond, VA

October 2018

## Acknowledgments

I would like to thank my committee members, Dr. Zhao Lin, Dr. Harvey Schenkein and Dr. Thomas Waldrop for their guidance and this opportunity. I would also like to thank Dr. Caroline Carrico, Dr. Chongxia, Dr. Jie Cao, Dr. Mingxu Sun and Neal Esplin for their support and contribution in the success of my thesis. Lastly, I wish to express my gratitude and appreciation to the pillars of strength and support in my life, my partner Pye Kyu, my parents Lewis and Khine and my brother Jerry for their support every step of the way.

## Table of Contents

<b><u>Acknowledgments</u></b> .....	<b>ii</b>
<b><u>Table of Contents</u></b> .....	<b>iii</b>
<b><u>List of Tables</u></b> .....	<b>iv</b>
<b><u>List of Figures:</u></b> .....	<b>v</b>
<b><u>Abstract</u></b> .....	<b>1</b>
<b><u>Introduction</u></b> .....	<b>2</b>
<b><u>Methods and Materials</u></b> .....	<b>17</b>
<b><u>Results</u></b> .....	<b>21</b>
<b><u>Discussion</u></b> .....	<b>23</b>
<b><u>Conclusion</u></b> .....	<b>26</b>
<b><u>Figures</u></b> .....	<b>27</b>
<b><u>References</u></b> .....	<b>33</b>

### List of Tables

Table 1: Clinical studies using cell therapy for periodontal regeneration.....	10
Table 2: Application of exosome-mediated regenerative medicine .....	13
Table 3: tRF/tiRNA differentially expressed between Cell NT and Cell OM groups.	30
Table 4: tRF/tiRNA differentially expressed between Exo NT and Exo OM groups.	32

### List of Figures:

Figure 1: Pathogenesis of Periodontitis .....	2
Figure 2: Periodontal regeneration .....	8
Figure 3: tRNA fragment and exosome therapy .....	12
Figure 4: tRNA fragments .....	15
Figure 5: Method Flowchart .....	19
Figure 6: Gene Sequencing Work Flow Sheet .....	19
Figure 7: Bioanalyzer result illustrating the presence of RNA. ....	27
Figure 8: Quality Score. The percentage of bases with Q>30 should be greater than 80% .....	27
Figure 9: Summary of the mapping results of aligned reads by sample. Each sample consists of reads that can be classified into: mapped to pre-miRNA and mapped to tRF & tiRNA .....	28
Figure 10: Length distribution of the 4 different groups .....	28
Figure 11: The tRF/tiRNA gene expressing level in the Cell NT group .....	29
Figure 12: The tRF/tiRNA gene expressing level in Cell OM group .....	29
Figure 13: The tRF/tiRNA gene expressing level in the Exo NT group .....	31
Figure 14: The tRF/tiRNA gene expressing level in the Exo OM group .....	31

## Abstract

### **tRNA Profiling of Mesenchymal Stem Cell Exosome**

A thesis submitted in partial fulfillment of the requirements for the degree of a Master of Science in Dentistry at Virginia Commonwealth University

By

Khin MiMi San  
University of Pretoria, South Africa, 2011

Director: Zhao Lin  
Assistant Professor, Department of Periodontics

Graduate Periodontics  
Virginia Commonwealth University

**Background:** Exosomes have great potential in regenerative medicine through the transfer of their bioactive cargos, such as RNA. tRF RNA and tiRNA are tRNA-derived non-coding RNA. Here, we sought to identify the tRF/tiRNA profile in human mesenchymal stem cell (hMSC) exosomes. **Methods:** Bone marrow hMSCs were cultured with/without osteogenic differentiation medium and exosomes were harvested. RNA was extracted from: 1) control cells (Cell-NT); 2) control exosomes (EXO-NT); 3) differentiated cells (Cell-OM); 4) exosomes produced by differentiated cells (EXO-OM). RNA was sequenced to profile the small RNA with a focus on tRF/tiRNA. **Results:** tRF/tiRNA was highly enriched in hMSC exosomes. Less diversity was seen in the tRF/tiRNA profile in exosomes than that in parent cells. Selective tRF/tiRNA were packed into MSC exosomes and their profile is dependent on the cell maturation status. **Conclusions:** Our results suggest that tRF/tiRNA may play a role in mediating the function of exosomes in tissue regeneration.

**Keywords:** Mesenchymal Stem Cell, Exosome, Regeneration, tRNA



## Introduction

### Periodontal Disease

Periodontal disease is one of the most prevalent inflammatory diseases, affecting an estimated 47 percent of the American population.<sup>1</sup> It is characterized by a chronic, persistent immune response to a dysbiotic periodontal biofilm that results in destruction of the hard and soft tissue surrounding teeth.<sup>2</sup> Factors including genetics, and environmental and acquired disease modifiers affect the pathogenesis of periodontitis.<sup>3</sup>

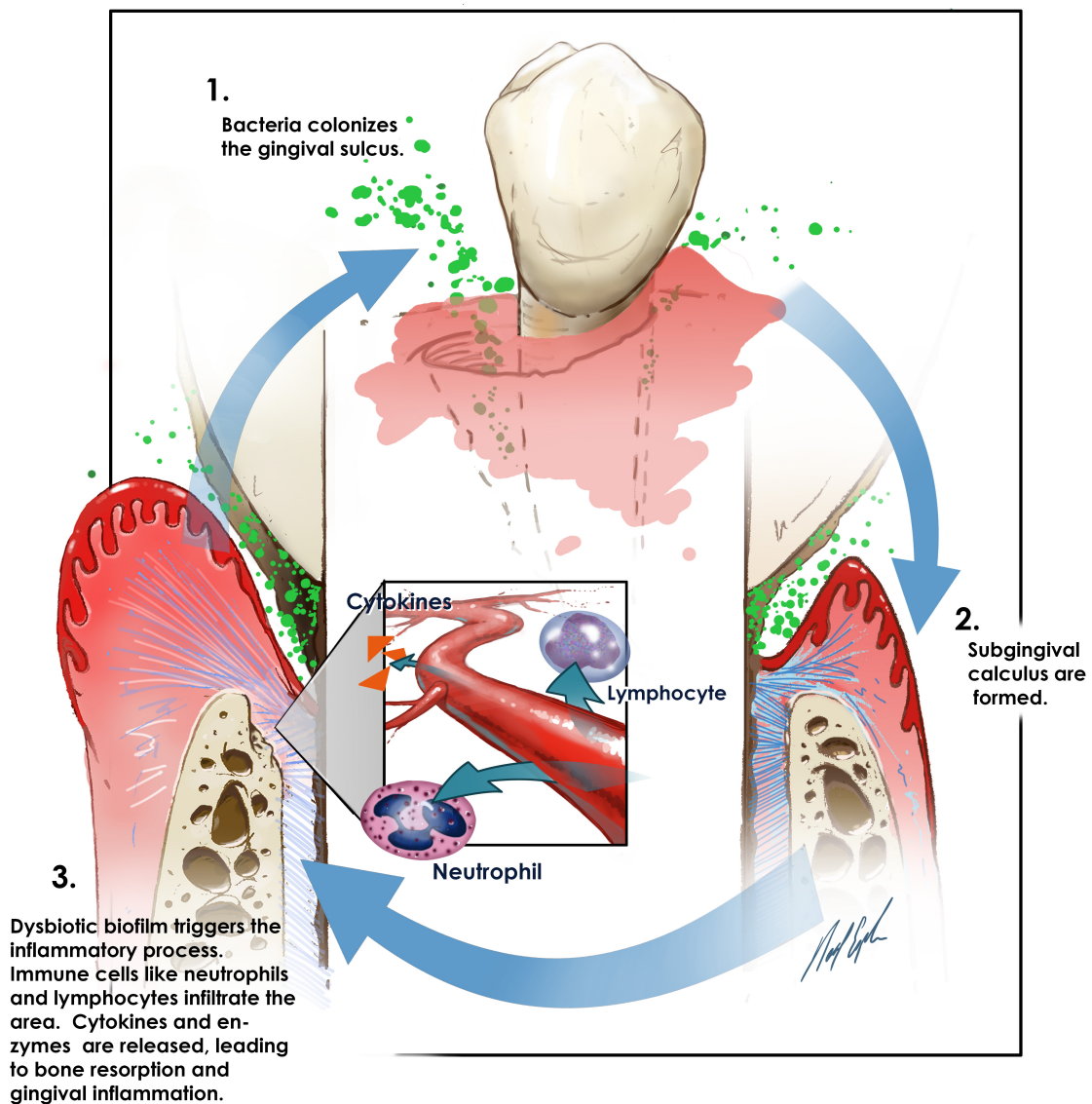

Figure 1: Pathogenesis of Periodontitis

The clinical manifestations of periodontitis are due to a complex relationship between the disease modifiers and the microbial challenge.<sup>3</sup> The disease presents as the inflammation of the supporting periodontal tissue around teeth resulting in deep periodontal probing depths, attachment loss and suppuration which can lead to tooth mobility and future tooth loss. Microbiological models proposed by Hajishengalis suggest the involvement of keystone pathogens, or specific microorganisms, are associated with periodontal destruction.<sup>4</sup> The bacteria exhibit the expression of diverse molecules and virulence factors, resulting in a pro-inflammatory response, responsible for the ultimate tissue destruction.<sup>4</sup> This model proposes that periodontal inflammation is due to the transition of microbial communities from commensal to pathogenic.<sup>2</sup> One of the keystone pathogens, *Porphyromonas gingivalis* (P.g), is responsible for the periodontal tissue destruction by its virulence factors such as lipopolysaccharides (LPS) and gingipains. The virulence factors trigger a host immune regulatory response including the infiltration of immune cells and the release of cytokines (Fig 1).<sup>4</sup>

It is believed that even at low numbers, microorganisms that are commensal in nature can become pathogenic. This can result in the derangement of the host immunity.<sup>2</sup> Interleukin-6 is a cytokine that plays a role in tissue destruction and is known to be produced by many cell types.<sup>5</sup> The immense production of cytokines creates a substantial impact on the immune system and stimulate alveolar bone loss by activating osteoclastogenic pathways.<sup>6</sup> The receptor activator of nuclear factor kappa B ligand (RANKL) is one of the most important cytokines in osteoclast differentiation. RANKL is produced by stimulated T cells and stromal cells.<sup>7</sup> Hence, understanding the role of immune regulation has laid the foundation for the therapy

of periodontitis.

Current treatment options for periodontitis include non-surgical and surgical therapy. The outcome of non-surgical therapy is usually limited. For patients with slight or moderate disease, non-surgical therapy may be adequate to prevent disease progression and resume periodontal health. However, in severe disease, the success of non-surgical therapy is usually limited. Studies show that non-surgical therapy such as scaling and root planning in severe cases reduces probing depths but residual calculus is observed, even after repeated instrumentation in deep pockets.<sup>8</sup>

In addition to controlling the inflammation, the reconstitution of functional periodontal structure is another important treatment goal. The tissue healing that is usually noted with non-surgical therapy is new attachment or repair. New attachment is the restoration of the area with connective tissue and cementum, while a repaired zone is the establishment of a long junctional epithelium in a previously diseased site. Regeneration allows the complete structural and functional reconstruction of the affected periodontal apparatus, which is an important therapeutic endpoint for periodontal regenerative medicine. The goal of regenerative periodontal therapy is to restore the supporting apparatus around a tooth that has been lost, which includes the reconstitution of the periodontal ligament (PDL), cementum and bone.<sup>9</sup>

### **Periodontal Regeneration**

Different therapeutic modalities such as guided tissue regeneration (GTR), biologics in the form of growth factors/peptides and stem cell therapy aim at regeneration of the periodontium. GTR relies on epithelial cell exclusion to allow PDL, cementum

and bone to regenerate at different rates.

Adequate angiogenesis provides blood supply and mesenchymal stem cells to the area of injury to facilitate healing events.<sup>10</sup> The cascade of events of guided regeneration prevents fibroblast and other soft tissue cells from infiltrating the site. Engler et al. showed that epithelial cells can regenerate at a faster rate, up to 10 times that of the remaining periodontal tissue.<sup>11</sup> The concept of epithelial cell exclusion is for the mesenchymal stem cells (MSCs) from PDL and alveolar bone to migrate into the defect, allowing the slower-migrating cells with osteogenic potential to instead repopulate the site.<sup>12</sup>

Nyman et al. demonstrated guided tissue regeneration using non-resorbable membranes (Millipore filters).<sup>13</sup> The study histologically illustrated the regenerative potential of periodontal ligament cells through repopulation of the pluripotent PDL cells and new cementum.<sup>13,14</sup> Gottlow et al. further confirmed the establishment of new regenerated tissue using Gore-Tex membranes.<sup>15</sup> Collagen fibers were shown to insert into the new cementum.<sup>15</sup>

Regeneration has been shown to be dependent on the defect type and morphology. Cortellini et al. found 3 wall defects had the most predictable outcome with defects were filled up to 95% of the original depth compared to 82% for 2 wall defects and 39% for 1 wall.<sup>16</sup> This highlights the importance of defect morphology. The containment and selection of the defect will contribute to the success of treatment.

Space maintaining is another fundamental principle in the success of guided tissue regeneration.<sup>10</sup> Autogenous bone and different bone substitutes are space maintainers for tissue growth.<sup>10</sup> Reynolds et al. showed in a systematic review that

improvement in clinical parameters was greater with both graft and barrier than barrier alone.<sup>17</sup> Graft materials used in regenerative periodontal therapy can be classified into three categories based on their impacts on bone formation: osteogenesis, osteoinduction, osteoconduction. If living cells are present in a graft material, it therefore has an osteogenic effect, as bone cells will directly contribute to the bone formation.<sup>18</sup> Unlike osteogenesis, osteoinduction involves the recruitment of immature cells and the induction of these cells to develop into preosteoblast.<sup>19</sup> Osteoconductive bone graft material can only serve as a scaffold for new bone growth by maintenance of space, and do not induce ectopic bone formation.<sup>18</sup> Knowledge of these mechanisms is essential for understanding the use and limitations of different bone graft methods for intrabony and furcation defects.

Autogenous bone directly from the patient is currently the only bone graft that has all three features of osteogenesis, osteoinductivity and osteoconductivity. Limitations of autogenous bone include added operative time for harvesting the graft, graft resorption, donor site morbidity and limited availability in children.<sup>20</sup> Therefore alternatives have been used in guided tissue regeneration, which include harvesting tissue from individuals of the same species (allograft), tissue from other species (xenograft) and synthetically produced material (alloplast).<sup>21</sup> Unfortunately, limited biological activity is associated with these alternatives. Although bone morphogenetic proteins (BMPs) found on demineralized freeze-dried bone (DFDBA) provide the osteoinductive potential, many studies have shown that the osteoinductive potential of DFDBA has significant variance amongst different tissue banks and donors.<sup>20</sup>

Biologics (namely those with growth factors) include platelet-derived growth factor

(PDGF-BB), enamel matrix derivative (EMD) and BMPs provide key cellular signals for bone, PDL and cementum regeneration.<sup>22,23</sup> These growth factors can be used in conjunction with bone grafts to enhance the biological activity of bone. It also stimulates angiogenesis that can compensate for the limitations of the bone graft. However, application of both biologics and bone graft make the treatment expensive.<sup>20</sup>

Although significant success has been obtained from the use of aforementioned technologies in periodontal regeneration, systematic reviews of literature suggest that the degree of tooth –supporting tissue regeneration is still suboptimal with less than 50 % bone regeneration and 20% horizontal defect fill.<sup>24</sup> Limited clinical outcomes are associated with the different regenerative strategies. Therefore, novel therapies are still needed to promote the clinical outcome.

Clinical success has been obtained from the use of donor bone and soft tissue regimens and the application of growth factors. However, due to the limitations of autogenous tissue, stem cell therapy is a promising alternative.<sup>25</sup>

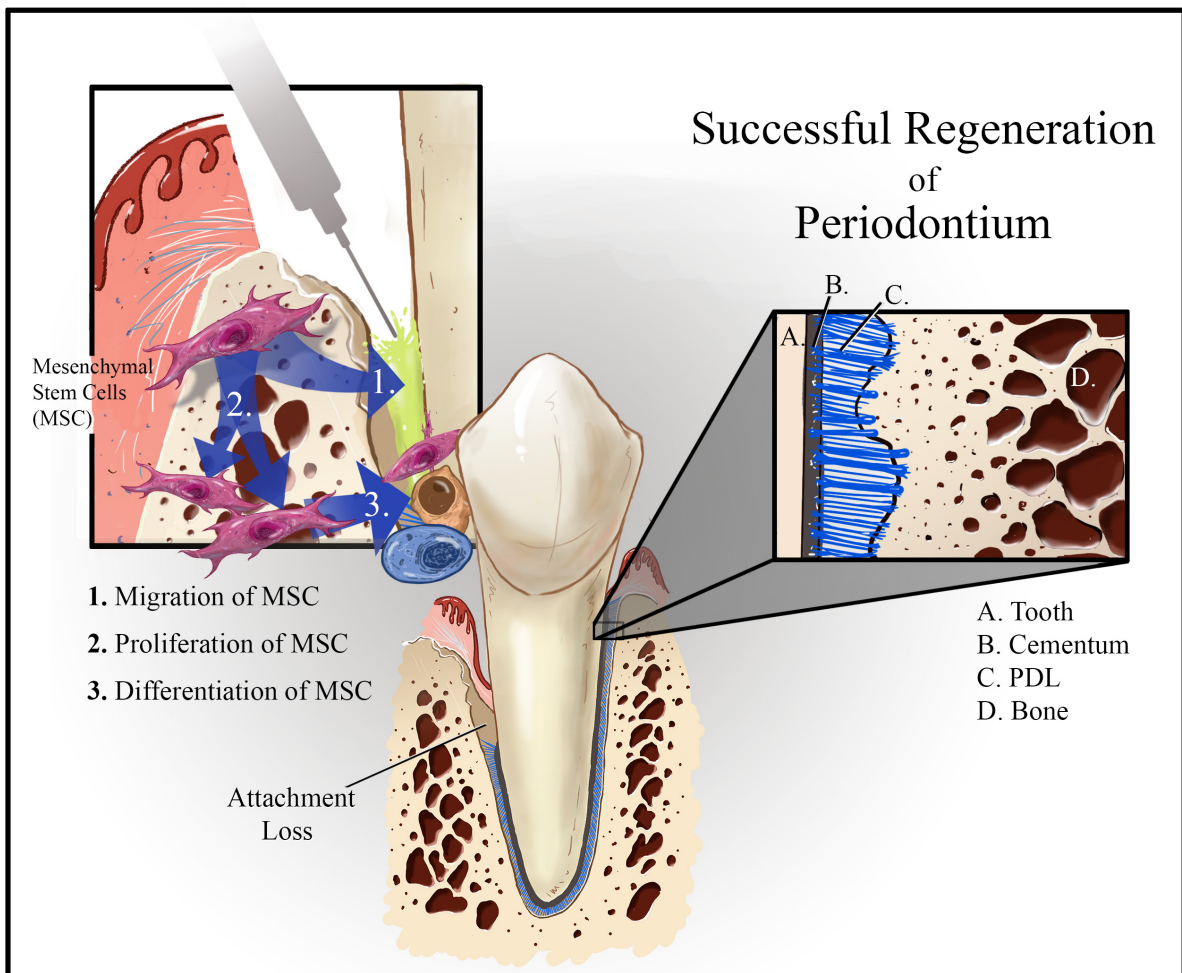

**Figure 2: Periodontal regeneration**

### **Cell-Mediated Therapy**

Cell therapy is being intensively investigated in animal models and clinical trials for the treatment of a broad range of diseases and injuries, including periodontitis.

Increasing evidence suggests the therapeutic value of mesenchymal stem cells (MSCs) are derived from the wide range of bioactive molecules that they secrete, which exert pleiotropic effects during wound healing such as stimulating proliferation and differentiation, enhancing angiogenesis and modulating host immune responses.

<sup>26,27</sup> MSCs respond in an adaptive way to environmental stimulation by modulating the transcription and translation process. Injury stimulates MSCs homing and the release of trophic factors by interactions between the C-XC chemokine receptor 4 (CXCR4) and stromal cell derived factor 1a.<sup>27,28</sup> Other examples of the trophic

factors include Substance P, a neurotransmitter which mobilizes the CD29 stromal – like cell, that induces accelerated wound healing and promotes repair of corneal injury.<sup>29</sup> MSCs from different sources (e.g. bone marrow, adipose tissue) vary in differentiation potential and angiogenic ability to other cell types such as adipocyte, osteoblast and chondrocyte.<sup>30</sup>

Table 1. Summarizes recent human studies using MSCs for regeneration in dentistry. Yamada et al. reported that the localized injection of MSCs into an open interproximal space resulted in an improved interproximal papilla fill of 2.55mm. Kaigler et al. further showed a significant result in the bone density of patients who received engineered stem cell therapy for sinus augmentation.<sup>31,32</sup> Results from this study were noted both radiographically and histologically. These studies support the therapeutic outcome of stem cell delivery and provide alternative treatment to periodontal hard and soft tissue regeneration.



<u>Study</u>	<u>n.</u>	<u>Study Type</u>	<u>Status</u>	<u>Cell Source</u>	<u>Cell expansion in Lab</u>	<u>Delivery carrier</u>	<u>Outcome</u>
Yamada et al.	17	Case report	Completed	Autologous BMSC from iliac crest	Yes	PRP, thrombin/10% calcium chloride	5.12 PD loss, 4.29 CAL gain, 3.12mm bone gain
Feng et al.	3	Case report	Completed	Autologous PDL cells from third molars	Yes	Synthetic bone grafting material	No adverse effects during 32-72 months.
Chen et al.	35	RCT	Recruiting	Autologous PDL cells from third molars	Yes: cell sheet technique	N/A	N/A
Gjerde et al.	11	RCT	Completed	Autologous BMSC from iliac crest	Yes	Biphasic calcium phosphate granules	No adverse effect and regeneration of bone (GBR) noted for implant placement.
Kiagler et al.	24	RCT	Completed	Autologous BMSC from iliac crest	Yes	Tricalcium Phosphate scaffold	Comparable results to GBR control group but better bone density noted in the stem cell therapy group.

Table 1: Clinical studies using cell therapy for periodontal regeneration.<sup>24,32,33</sup>

However, limitations still exist in the current cell-based therapy as the treatment effect is usually dose dependent and a large number of MSCs will be needed to produce the desired effect. Mesenchymal stem cells are difficult to isolate and to select the optimal cell population for treatment is still under investigation.<sup>14</sup> Additional equipment is needed to store the cells, making it uneconomical for dental practice. New therapies are currently being investigated and exosome therapy is a promising substitute.

### **Exosome-mediated regenerative therapy**

Exosomes are nanoscopic lipid bilayer vesicles (~100 nm in diameter) secreted by most cell types.<sup>34,35</sup> They are formed inside the multivesicular endosomes and released when multivesicular bodies fuse with the plasma membrane. Various

molecular constituents from their cell of origin are selectively packed into exosomes.<sup>36</sup> They were originally believed to be a vehicle to clear proteins from cells; however, studies are currently investigating other functions of these multivesicular bodies. Instead, emerging as novel mediators in cell-cell communication, exosomes have been shown to be involved in various physiological and pathological processes including immune response, embryonic development, tumorigenesis, and wound healing.<sup>37</sup> In regenerative medicine, MSC exosomes have been reported to promote tissue healing in different organs such as heart, lung, kidney, liver and brain, demonstrating a promising clinical value as a substitute of cell delivery based treatment.<sup>38</sup>

Exosomes contain multiple protein molecules such as annexins, tetraspanins (CD63, CD81 and CD9), heat shock proteins and low amounts of phosphatidylserine and cell specific proteins, that have an evolutionarily conserved function during exosome biogenesis.<sup>28,39</sup> An association exists between the molecular markers on an exosome and that of their parent cell; hence they may have similar properties. Like the mesenchymal parent cells, which have functions in tissue-repair promotion, anti-inflammation, immunosuppression and neuroprotection, exosome mediated therapy has been shown to have similar therapeutic effects.<sup>40</sup> It is still largely unknown about how exosomes exert their function; however, the enclosed RNA has been considered the major mediator for the cellular responses induced by exosomes.

### tRNA Fragments from Bone Marrow Mesenchymal Stem Cell Exosome

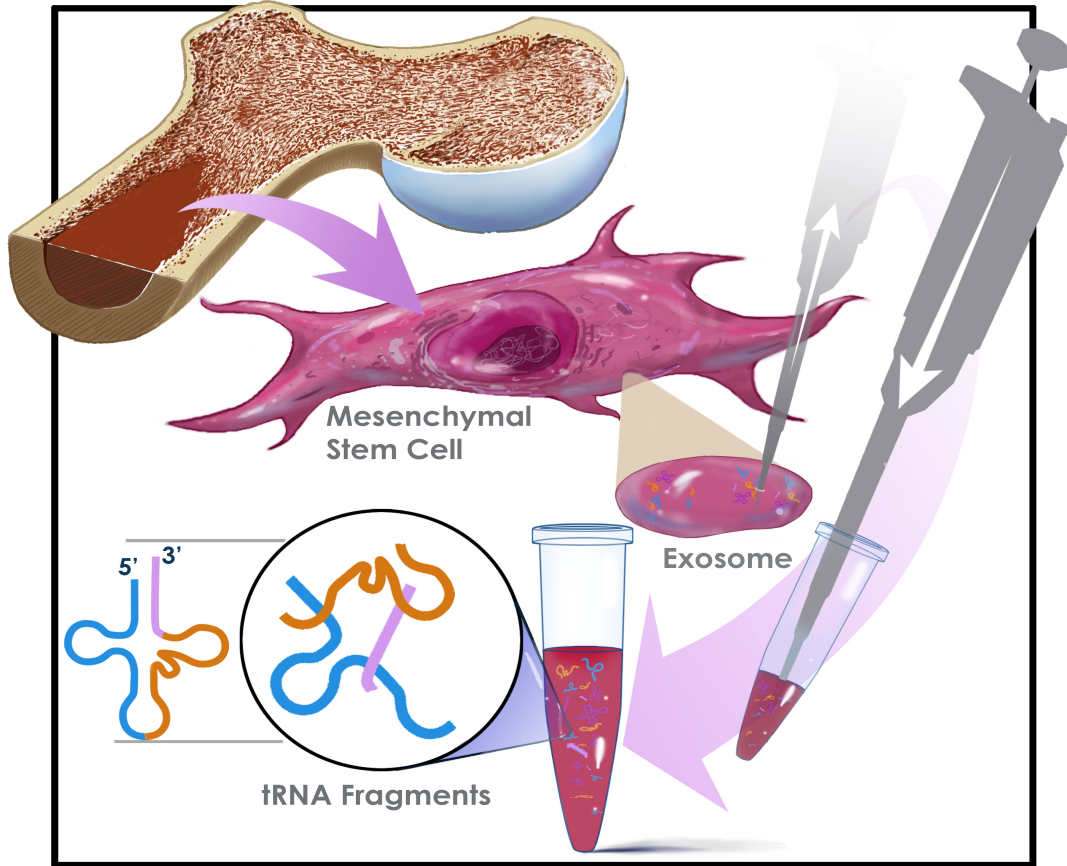

Figure 3: tRNA fragment and exosome therapy

Exosome based therapy has emerged as a viable alternative therapy for stem cell delivery.<sup>41</sup> The advantage of exosome delivery to conditional cell therapy include the feature that it triggers a less immunogenic response than the parent cells and can be stored for up to 6 months under  $-20^{\circ}\text{C}$  temperature without any alterations in the biological make up and activity.<sup>28</sup> Another significant advantage is that the cargos inside exosomes are better protected from degradation than their parent counterpart, which may provide a more predictable clinical outcome.

The regenerative potential of MSC exosomes has been demonstrated in different disease models. Treating mice with myocardial ischemia /reperfusion injury, with

exosome based therapy from cardiosphere derived cells, showed a decrease in infarct size.<sup>42</sup> An enhanced cardiac functionality, reduction in scar tissue and an increase in viable tissue were also seen after exosome therapy. Further study showed that therapeutic effects were partially mediated by the enclosed miRNAs.<sup>42</sup> Exosomes excreted by MSCs were found to activate pro-survival signaling by reducing oxidative stress, resulting in decrease tissue destruction.<sup>28</sup>

The interest of applying exosomes for bone regeneration has increased over the years. Intravenous infusion of MSC exosomes significantly ameliorated the osteoporotic phenotype in systemic lupus erythematosus (SLE) mice.<sup>43</sup> Very recently, it was shown that exosomes produced by MSCs derived from induced-pluripotent stem cells or bone marrow, enhanced bone formation in critical size calvarial defects.<sup>26,44,45</sup> In addition, MSC exosomes also contain other functions such as immune modulation, anti-oxidation, etc (Table 2).<sup>46-48</sup>

<u>Target organ</u>	<u>Function and Role</u>	<u>Therapeutic benefits and mechanism</u>
Cardiovascular disease	<ul style="list-style-type: none"> <li>• Angiogenesis</li> <li>• Antifibrosis</li> <li>• Anti apoptosis</li> <li>• Anti oxidation</li> <li>• Chemo attraction</li> </ul>	<ol style="list-style-type: none"> <li>1. Reduce infarct size</li> <li>2. Enhance tissue repair</li> <li>3. Increase angiogenesis</li> </ol>
Cutaneous wound healing		<ol style="list-style-type: none"> <li>1. Increase re-epithelization.</li> <li>2. Inhibit apoptosis of skin cell</li> <li>3. Promote proliferation of skin cells</li> </ol>
Kidney damage		<ol style="list-style-type: none"> <li>1. Tubuloepithelial regeneration</li> <li>2. Reduce tubular cell apoptosis</li> <li>3. Reduce fibrosis</li> <li>4. Reduce tubular atrophy</li> </ol>
Liver injury		<ol style="list-style-type: none"> <li>1. Hepatocyte regeneration</li> <li>2. Inhibit liver fibrosis</li> <li>3. Reduce hepatocyte apoptosis</li> </ol>
Lung injury		<ol style="list-style-type: none"> <li>1. Reduce lung edema</li> <li>2. Reduce inflammation</li> <li>3. Improve pulmonary hypertension.</li> <li>4. Improve ventricular hypertrophy.</li> <li>5. Improve lung vascular remodeling.</li> </ol>

Table 2: Application of exosome-mediated regenerative medicine.<sup>48-52</sup>

### **tRNA, tiRNA, tRF and their significance.**

Through next generation RNA sequencing, we found that significant amounts of transfer RNA (tRNA) exist in MSC exosomes. tRNA is an adaptor molecule that decodes mRNA and translates proteins. Recent studies have demonstrated that tRNAs are also a major source of small non-coding RNAs (ncRNAs). These tRNA-derived ncRNAs are not random degradation products of tRNA, but rather produced through precise cleavages by specific nucleases. In general, tRNA-derived ncRNAs are classified into two main categories: tiRNA (tRNA halves) and tRF (tRNA-derived fragments).

The biogenesis of tRF/tiRNAs is shown in Fig 6. Briefly, tRFs are generated by multiple cleavages of tRNA precursors or mature tRNA. These products are classified by their sites of origin: 1) tRF-5: these RNA are from the 5' part of the mature tRNA and the cleavage occurs at the D loop; 2) tRF-3: these RNA correspond the 3' parts of mature tRNAs containing 3'CCA termini and formed by the cleavage of the T loop; 3) i-tRF: these RNA are derived from the internal region of the mature tRNA and usually contain the anti-codon loop; 4) tRF-1: these RNA originate from the beginning of the 3'end flanking sequences with poly-U residue at 3'end. tRFs are ~16-25 nucleotides in size and deeply conserved in nature. Little is known about the molecular mechanism underlying the generation of tRFs. In many cases, tRFs appear to be produced in a manner similar to the canonical miRNA pathway. However, a DICER-independent tRF production mechanism was identified recently.<sup>53</sup> tiRNA is formed when the tRNA molecule is cleaved at the anticodon to produce 30–35 nucleotide 5'-tRNA halves and 40–50 nucleotide 3'-tRNA halves.<sup>42</sup> tRF molecules are smaller than the tiRNA halves and angiogenin is responsible for this cleavage.<sup>42</sup>

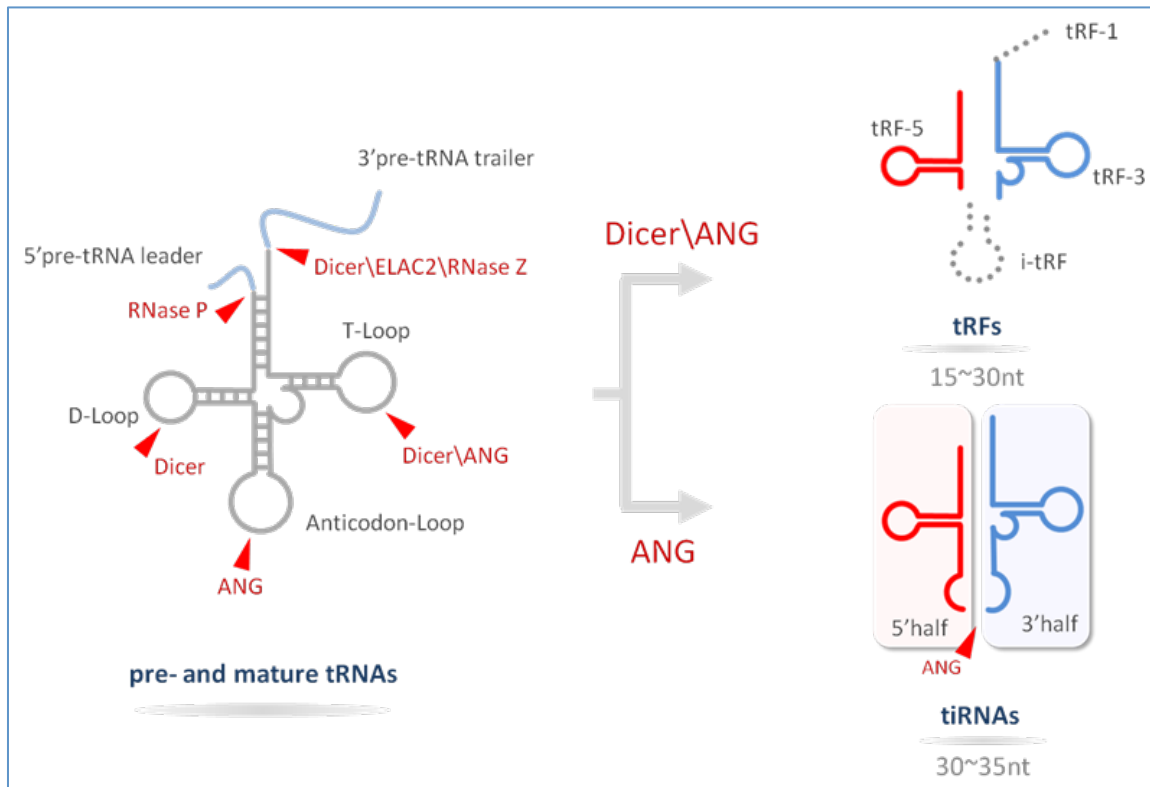

Figure 4: tRNA fragments

It is believed that tRFs and tiRNA exert their biological functions as small noncoding RNAs. For example, they can inhibit gene expression and block protein translation in a similar manner as microRNA.<sup>8</sup> They can also directly inhibit protein synthesis by displacing the translation initiation factor eIF4G from mRNA.<sup>42</sup> They regulate the stability of protein complexes through RNA and protein interaction.<sup>42</sup> They also play a role in stress response by assembling stress granules. Emerging in vivo evidence start to reveal the important functions of tRF/tiRNA. It has been shown that an acquired metabolic disorder can be transferred to offspring through the tRNA fragments.<sup>42</sup> Injection of sperm tRF/tiRNA fractions from mice with metabolic disorders induced by a high-fat diet to normal zygotes resulted in a similar metabolic disorder in the F1 offspring. These results and others suggest the epigenetic nature of the tRNA fragments in the extracellular vesicles/exosomes and show their important role in a variety of physiological and pathological conditions, such as spermatogenesis, cancers, neurodegeneration, metabolic disorders, etc.<sup>42</sup>

**Because of the potential of exosomes as an alternative to stem cell therapy in regenerative medicine, our long-term goal is to develop an MSC exosome-based therapy to promote periodontal regeneration. Understanding the components of MSC exosomes will help us better design this novel therapeutic technique. Cells at different maturation stages may produce different exosomes. In this study, our aim is to determine if MSCs produce exosomes with different tRNA components during osteogenic differentiation. Results from this study will help to develop better therapeutics for periodontal regeneration based on MSC exosomes.**

## Methods and Materials

### Cell Culture

Mesenchymal stem cells of human bone marrow were ordered from RoosterBio Inc. (RoosterBio, MD, USA). These cells had the potential to differentiate into osteocytes, adipocytes and chondrocytes. These cells were cultured in a high Performance Basal Medium (RoosterBio, MD, USA) supplemented with Media Booster GTX (RoosterBio, MD, USA) and 1% Antibiotic/Antimycotic solution (10,000 units of penicillin, 10,000µg of streptomycin, and 25µg of Amphotericin B per mL, HyClone, USA) in T175 tissue culture flasks. The cells were subpassaged at 90% confluency. At passage 3 medium was then aspirated and the cells were washed for 3 times with warm PBS to completely remove the residue of expansion medium. The hMSCs were then cultured in control medium (denoted as NT, DMEM supplemented with 1g/L glucose, 10% exosome-depleted FBS and 1% Antibiotic/Antimycotic solution) or osteogenic medium (denoted as OM, control medium supplemented with ascorbic acid (50 ug/mL), dexamethasone ( $10^{-8}$  M) and  $\beta$ -glycerophosphate (5 mM)) for 4 days. After 4 days, medium was collected. For total cell RNA experiment, cells were cultured in 6 well plates with/without osteogenic medium for 4 days

### Extraction of Exosomes

Exosomes were isolated from the collected culture media at day 4 by sequential ultracentrifugation.<sup>54</sup> Briefly, hMSCs culture media was centrifuged at 500×g for 10 minutes, 2000×g for 10 minutes with a bench-top centrifuge (Beckman Coulter, USA). Then the supernatant was collected and centrifuged at 10,000×g for 30 minutes to remove large cell organelles such as lysosomes and mitochondria, followed by 100,000×g for 70 minutes to concentrate the exosomes. Then the supernatant was discarded and the pellet was resuspended in 0.9% NaCl and



centrifuged at 100,000×g for 70 minutes to remove the contaminated protein from the medium. The resulted exosome pellet was then resuspended in 0.9% NaCl and stored at -80 °C until further use. All centrifugation was performed at 4 °C.

### Extraction of RNA

The suspension of exosome (maximal volume=100ul) was added with 1 mL TRIzol. Samples were placed in -80 °C for a few minutes then thawed again and spun on a votex. Each sample was added with 0.2 mL of chloroform per 1mL of TRIzol sample and the caps of the tube were secured. The tubes were then vigorously shaken by hand for 15 seconds and then incubated at room temperature for 2-3 minutes. The sample was then centrifuged at 13,000 × rpm for 15 minutes at 4°C.

The aqueous phase of the sample was carefully removed by pipetting the solution into another tube without drawing any other phase. The medium was added with 0.5ml of 100% isopropanol to the aqueous phase, per 1 mL of TRIzol® Reagent, and incubated at room temperature for 10 minutes. After that, centrifugation of 13,000 × rpm for 15 minutes at 4°C was performed. The supernatant was then removed from the tube and the pellet was washed with 1 mL of 75% ethanol per 1 mL of TRIzol® Reagent with brief vortex. The sample then underwent centrifugation at 10,000 × g for 5 minutes at 4°C. The wash was then discarded. The RNA pellet was air dried for 5–10 minutes and resuspended in the RNase-free water by passing the solution up and down several times through a pipette tip or vortex.

The RNA concentration was determined by a bioanalyzer. RNA was sent to Arraystar for small RNA sequencing.

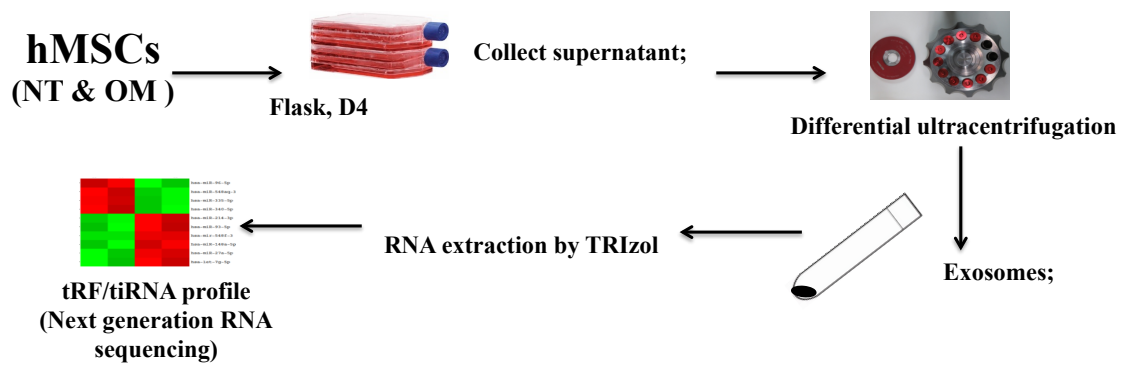

Figure 5: Method Flowchart

### Gene Sequencing

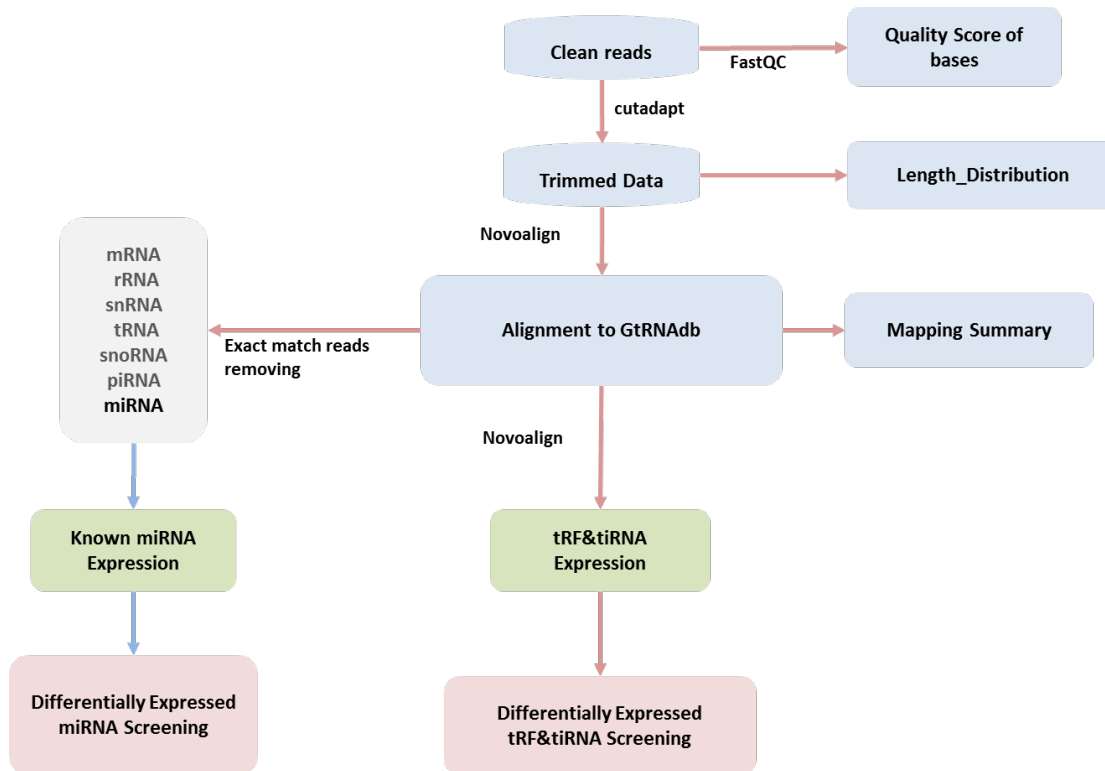

Figure 6: Gene Sequencing Work Flow Sheet

Total RNA samples were first pretreated as following to remove some RNA modifications that interfere with small RNA-seq library construction: 3'-aminoacyl (charged) deacylation to 3'-OH for 3' adaptor ligation, 3'-cP (2', 3'-cyclic phosphate) removal to 3'-OH for 3' adaptor ligation, 5'-OH (hydroxyl group) phosphorylation to 5'-P for 5'-adaptor ligation, m1A and m3C demethylation for efficient reverse transcription. Then pretreated total RNA was used to prepare the sequencing library in the following steps: 1) 3'-adapter ligation; 2) 5'-adapter ligation; 3) cDNA synthesis; 4) PCR amplification; 5) size selection of 135~160 bp PCR amplified fragments (corresponding to 15~40 nt small RNA size range). The libraries were denatured as single-stranded DNA molecules, captured on Illumina flow cells, amplified in situ as sequencing clusters and sequenced for 50 cycles on Illumina NextSeq 500 system per the manufacturer's instructions.

Image analysis and base calling were performed using Solexa pipeline v1.8 (Off-Line Base Caller software, v1.8). Sequencing quality was examined by FastQC software and trimmed reads (pass Illumina quality filter, trimmed 3'-adaptor bases by cutadapt) were aligned to mature-tRNA and pre-tRNA sequences from GtRNAb using NovoAlign software (v2.07.11). The remaining reads are aligned to the transcriptome sequences (mRNA/ rRNA /snRNA /snoRNA /piRNA /miRNA). The expression profiling and differential expression of tRFs & tiRNAs & known miRNAs were calculated based on normalized TPM. Hierarchical clustering, scatter plots and volcano plots were performed with the differentially expressed tRFs & tiRNAs in R or Python environment for statistical computing and graphics.

## Results

In Fig 7, electrophoresis in the bioanalyzer allowed the RNA to be visualized accordingly to the nucleotide length. The exosome groups illustrate a greater concentration of fragment RNA located in the nucleotide length below 200, while a greater diversity was seen in the cell groups which included patterns that resemble 28S, 18S,5S ribosomal RNA.

RNA was sent to Arraystar Inc. for library preparation and sequencing. Quality score (Q-score) is a prediction of the probability of an error in base calling during sequencing. For example, Q30 stands for one in every 1000 base calls that is predicted to be incorrect. Q20 means one base call is incorrect in every 100 sequenced bases. Q30 is considered a benchmark for quality in next generation sequencing. Fig.8 shows that all 4 groups show a high (>92%) and comparable Q30, indicating that the quality of our sequencing was high.

After data analysis, we found that the exosome and cell groups display distinct profile in terms of ratio of tRNA and miRNA. In the exosome, a large portion of the reads were aligned to the tRNA fragments, while in the cell groups, a larger portion were assigned to the micro-RNA as seen in Fig 9. Additionally, the length distribution in Fig.10 highlights the variation in nucleotide reads. The cell groups have a variable distribution in the nucleotide length while the exosome groups show a peak between 30-to 37-nucleotide. This is comparable to the length of tRNA fragments, indicating a greater expression of tRNA fragments in exosomes compared to the cell groups. Very interestingly, a dramatic difference was seen in the tRNA fragment species when the cells were compared to exosomes, regardless of their differentiation status(Fig 11-14). In the total cell RNA, the tRNA fragments were derived from a

wide range of tRNAs carrying different anti-codons, however the majority of the exosomal tRF/tiRNAs were from a limited number of parent tRNAs. Furthermore, more diverse tRNA fragments (tRF-5, tRF-3, tRF-1, i-tRF and tRNA halves) were found in cellular RNA. In exosomes, most of the tRNA fragments were tiRNA-5. Our data suggest that RNA in exosome is not a simple copy of cytosol RNA and only specific tRF/tiRNAs may be selectively packaged into the exosomes.

We also investigated whether the cell maturation status will impact the constituents of their exosomal tRF/tiRNA. We found that, the difference between two sample types (cell vs exosome) was much more dramatic than the difference between two different maturation stages (NT vs OM). However, some of the tRF/tiRNA were found differentially expressed between the non-differentiated and differentiated samples (Table 3 &4).

## Discussion

Exosome-based therapy has many advantages to current stem cell treatment. For example, exosomes are more resilient to degradation and can be stored for a longer time frame in proper conditions.<sup>28</sup> Emerging animal studies and early human clinical trials have demonstrated the safety and efficacy of exosome therapy.<sup>48</sup> For example, the injection of exosomes from cardiosphere cells (stem cells) decreased the ischemic area in experimental myocardial infarction models. Exosome therapy can ameliorate neurological disorders and promote healing through stimulating a multitude of pathways and associated with angiogenesis, cell proliferation and inflammation.<sup>43</sup> Preliminary results from our laboratory also suggested that exosome therapy is a potential substitute for stem cell delivery in bone regeneration. Therefore, to determine the active biological components in MSC exosomes, will have great value in understanding the therapeutic effects on exosome therapy.

This study elaborates the difference in tRF/tiRNA gene expression between the exosome groups and the parent cell groups. A large number of RNA in exosomes is mapped to tRF/tiRNA, which has not been reported before. Emerging evidence suggests the important functions of small tRNA fragments in development and diseases. For example, metabolic disorder can be transferred from parent to offspring by the tRNA fragments in the vesicles of sperm.<sup>55</sup> Significant difference was found in the tRF/tiRNA species between the exosomes and the parent cells, suggesting that RNA in exosome is not a simple copy of the cytosolic RNA and a selective mechanism is used to pack the tRF/tiRNA into exosomes. This is consistent with the observation in other exosomal RNA including microRNA.<sup>56,57</sup>

Interestingly, the presence of selective tRNA species may also be associated with the maturation status of stem cells. Although a smaller difference was seen between samples at two maturation stages when compared to that between exosomes and cells, a few tRF/tiRNA were found differentially expressed between the non-differentiated and differentiated samples. This is only the first step in appreciating the intricacy of these small tRNA fragments. In the future, more studies are needed to further determine the function of these differentially expressed tRF/tiRNA in MSCs.

Several limitations existed in our current study. We only sequenced one sample in each group. Studies with a larger n value would be required to assess if the differences and similarities are consistent across the different groups. It would also be interesting to see if there would be a greater difference when cells are treated for a longer period of time (> 4 days) with an osteogenic medium. A longer treatment may induce a more dramatic phenotypic change in MSC cells and exosomes, which therefore can impact the tRF/tiRNA component. Due to the technical limitations, the purity of our exosome may also be a concern. A standard sequential ultracentrifugation protocol was used in our study to isolate exosomes, however, some large protein complexes may still remain in the pellets. The purity of the exosome samples could be improved if a gradient ultracentrifugation is applied to further eliminate the proteins for RNA analysis.

So far, the mechanism of how the tRF/tiRNA are packed into the exosome is still unclear. The packaging process of exosomes seem selective, otherwise we would expect to see similar diversity in the tRF/tiRNA in the exosomes compared to that in the parent cells, highlighting that most tRF/tiRNA are tiRNA-5. In future, it will be

interesting to investigate if this selective packaging process is related to specific tRF/tiRNA structure.



## Conclusion

This study showed that: 1) small RNA was highly enriched in MSC exosomes; 2) A significant larger portion of MSC exosome RNA was identified as tRF/tiRNA when compared to that in parent cells; 3) to our surprise, less diversity was seen in the tRF/tiRNA in exosomes compared to that of total cell RNA, suggesting a selective mechanism may be involved in transporting the tRF/tiRNA into exosomes; 4) some of the tRF/tiRNA were found differentially expressed between the non-differentiated and differentiated samples. The exact functions of exosomal tRF/tiRNA are still to be determined but understanding the basic make-up of the exosome RNA will provide valuable insight to modulating the function of exosomes for future periodontal regenerative medicine.

## Figures

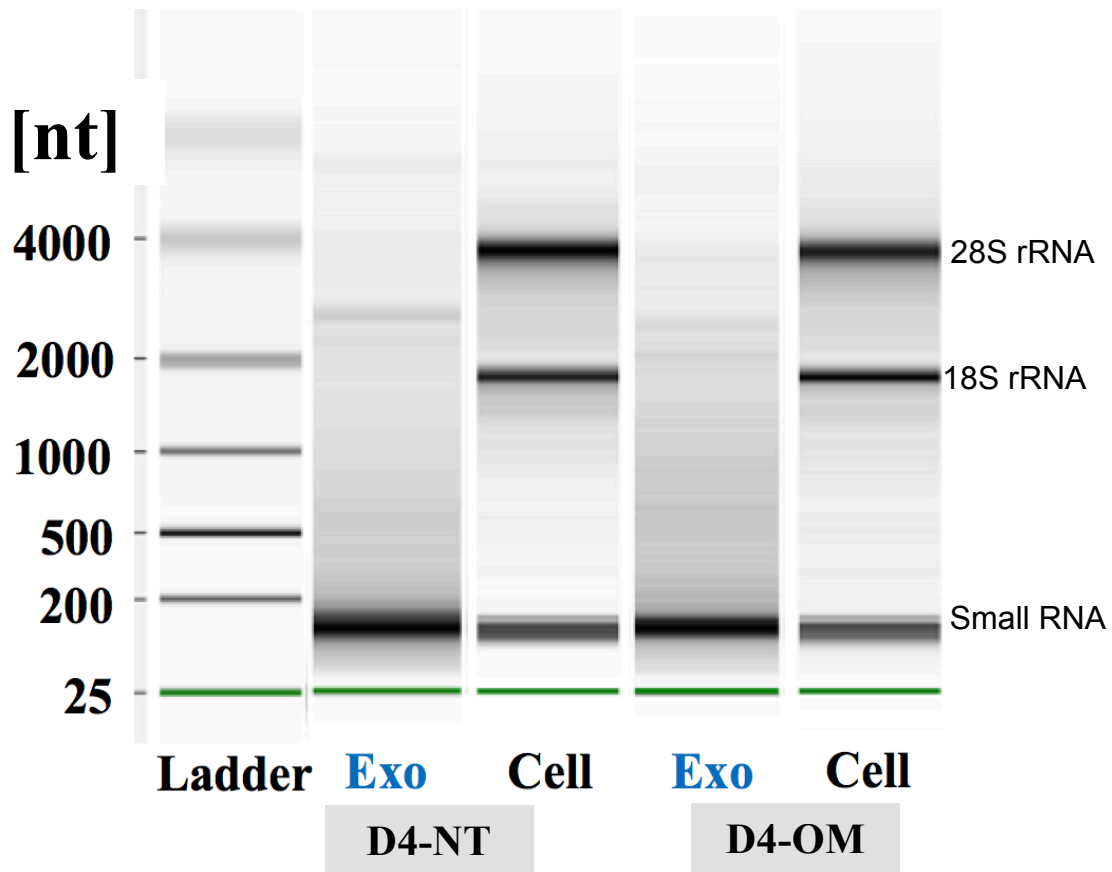

Figure 7: Bioanalyzer result illustrating the presence of RNA.

Sample Name	Number of Reads	Number of Reads (Quality Score $\geq 30$ )	Q30 Percent (%)
Exo_D4_NT	10616651	9931551	93.5
Cell_D4_NT	7749172	7195321	92.9
Exo_D4_OM	8891861	8188074	92.1
Cell_D4_OM	9696944	9085004	93.7

Figure 8: Quality Score. The percentage of bases with  $Q > 30$  should be greater than 80%

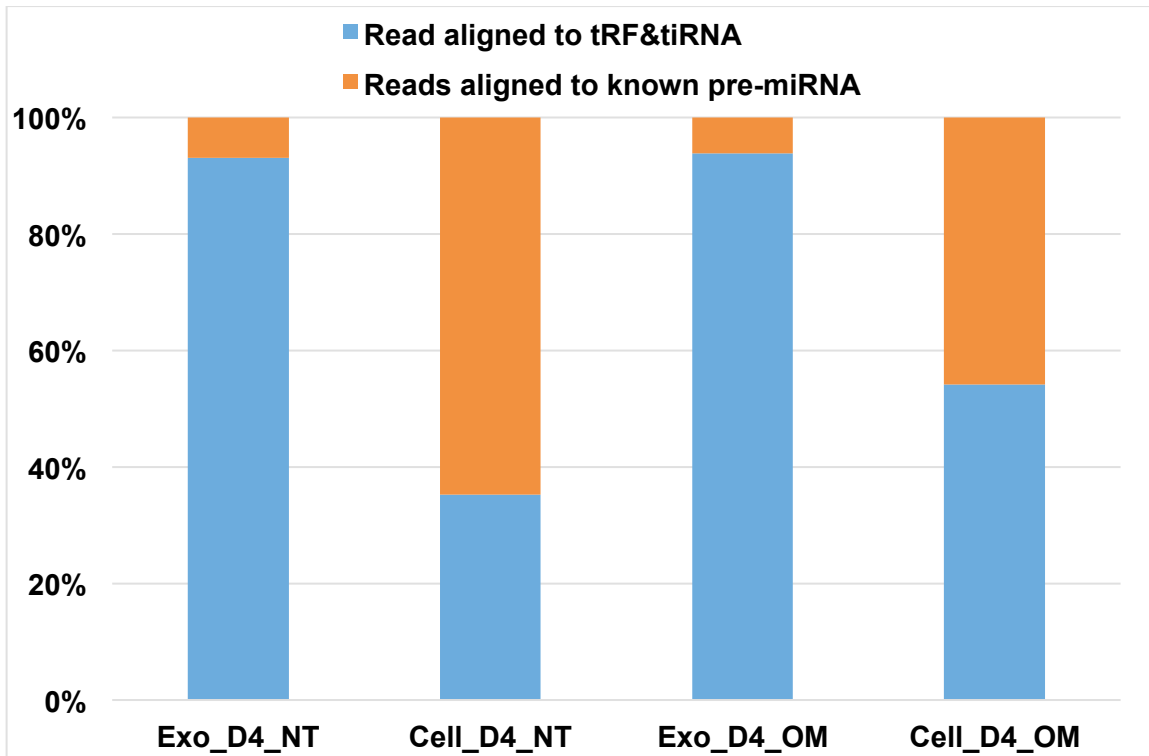

Figure 9: Summary of the mapping results of aligned reads by sample. Each sample consists of reads that can be classified into: mapped to pre-miRNA and mapped to tRF & tiRNA

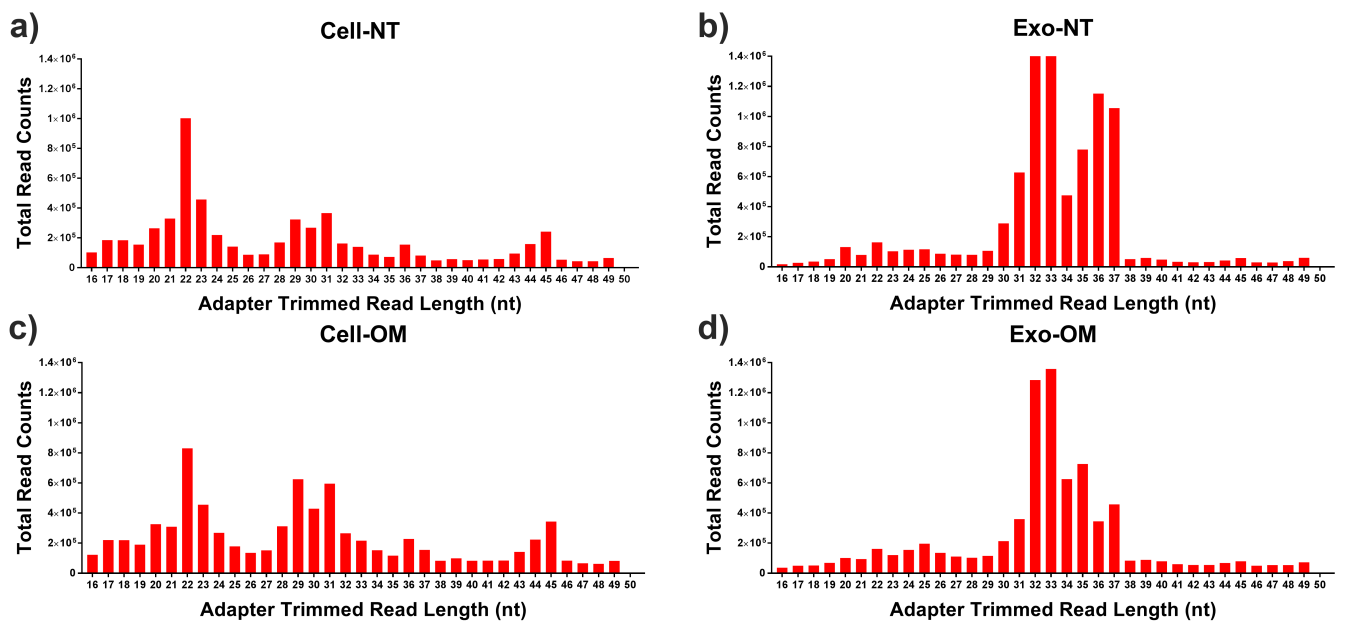

Figure 10: Length distribution of the 4 different groups

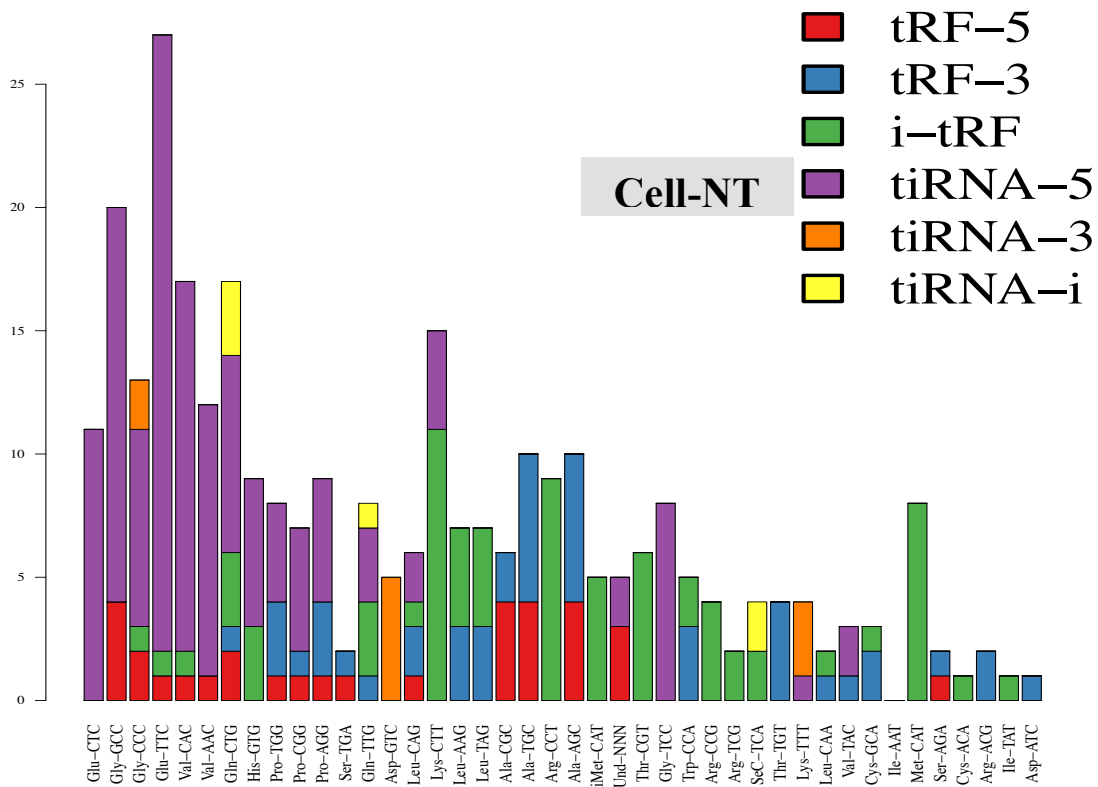

Figure 11: The tRF/tiRNA gene expressing level in the Cell NT group

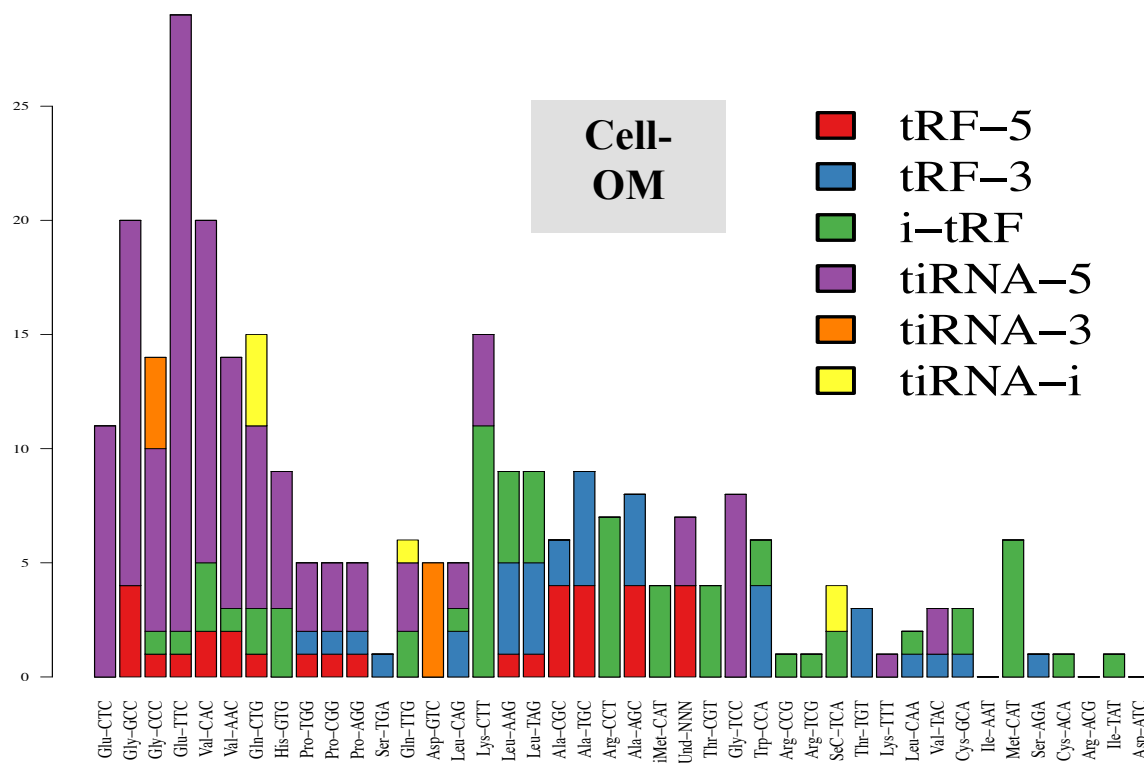

Figure 12: The tRF/tiRNA gene expressing level in Cell OM group

Gene sequence Cell NT	Gene sequence Cell OM	Small fragment tRNA species Cell NT	Small fragment tRNA species Cell OM
Val-AAC	Val-AAC	tRF-5 ti-RNA-5	tRF-5 i-tRF ti-RNA 5
Gln-CTG	Gln-CTG	tRF-5 i-tRF ti-RNA-5 tRF-3	tRF-5 i-tRF ti-RNA-5
Ser-TGA	Ser-TGA	tRF-3 tRF-5	tRF-3
Gln-TTG	Gln-TTG	i-tRF ti-RNA 5 ti-RNA i tRF-3	i-tRF ti-RNA 5 ti-RNA i
Leu -CAG	Leu -CAG	tRF-3 i-tRF ti-RNA 5 tRF-5	tRF-3 i-tRF ti-RNA 5
Leu-AAG	Leu-AAG	i-tRF i-tRF 3	i-tRF i-tRF 3 i-tRF 5
Leu-TAG	Leu-TAG	i-tRF i-tRF 3	i-tRF i-tRF 3 i-tRF 5
Lys-TTT	Lys-TTT	ti-RNA 5 ti-RNA 3	ti-RNA 5
Ser-AGA	Ser-AGA	tRF-3 tRF-5	tRF-3

Table 3: tRF/tiRNA differentially expressed between Cell NT and Cell OM groups.

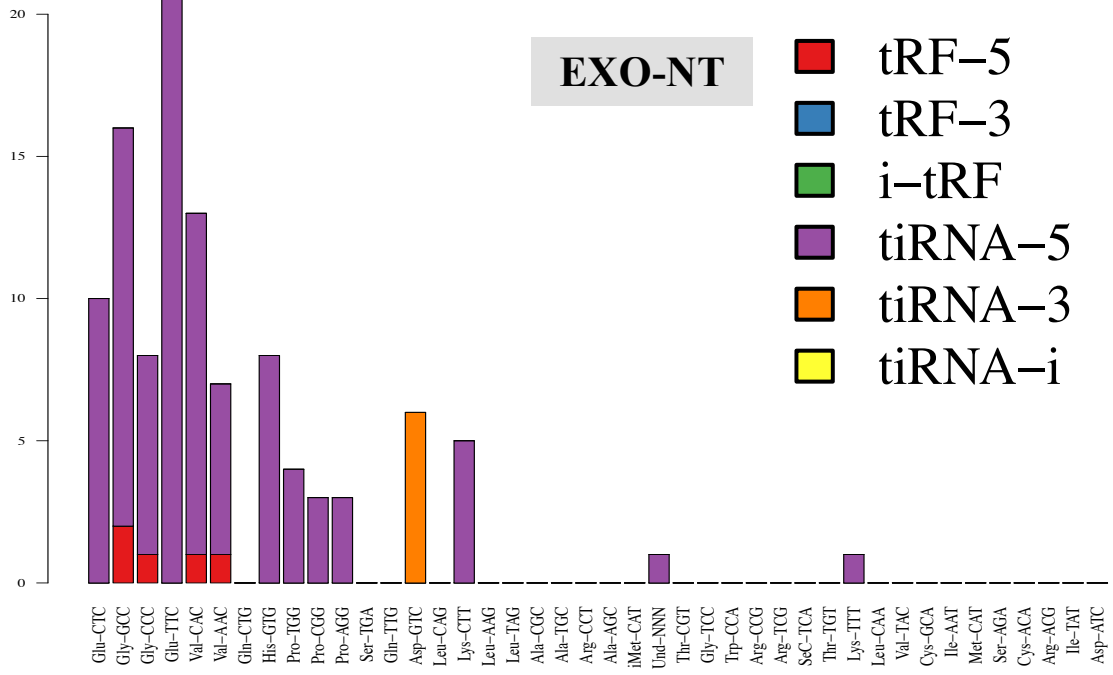

Figure 13: The tRF/tiRNA gene expressing level in the Exo NT group

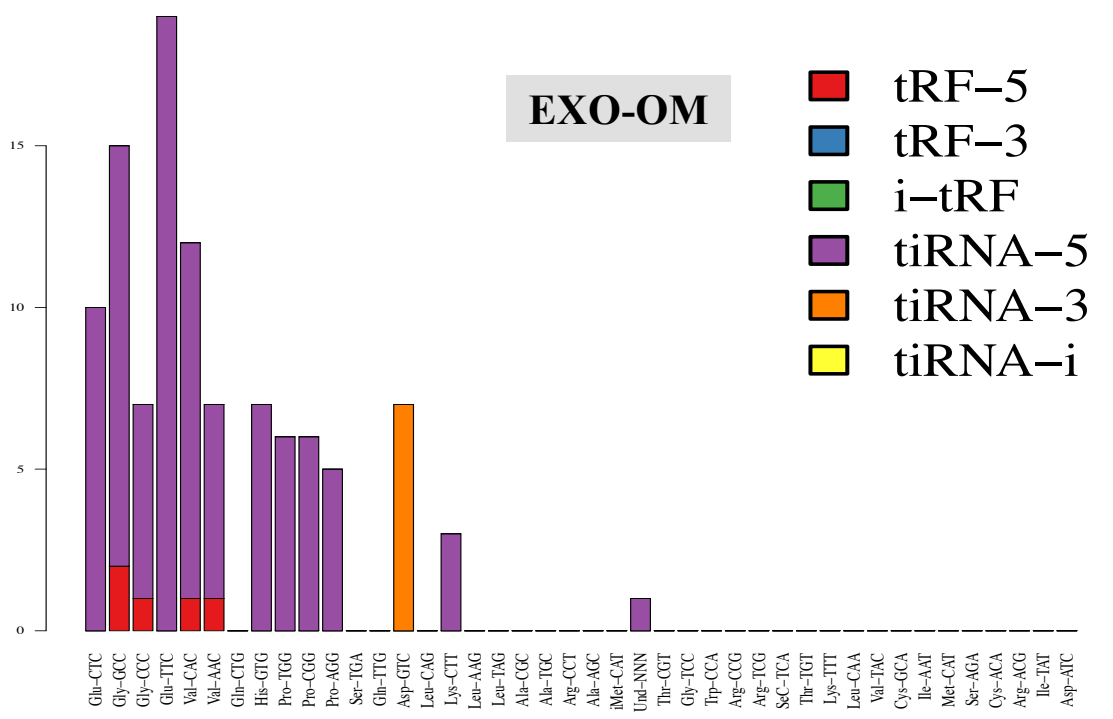

Figure 14: The tRF/tiRNA gene expressing level in the Exo OM group

<b>Gene sequence Exo NT</b>	<b>Gene sequence Exo OM</b>	<b>Small fragment tRNA species Exo NT</b>	<b>Small fragment tRNA species Exo OM</b>
Lys-TTT	Lys-TTT	tiRNA-5	-

**Table 4: tRF/tiRNA differentially expressed between Exo NT and Exo OM groups.**

## References

1. Eke PI, Dye BA, Wei L, Thornton-Evans G, Genco RJ. Prevalence of periodontitis in adults in the United States: 2009 and 2010. Vol. 91, Journal of dental research. 2012. p. 914–20.
2. Lamont RJ, Hajishengallis G. Polymicrobial synergy and dysbiosis in inflammatory disease. Trends Mol Med. 2015;21(3):172–83.
3. PAGE ROYC, OFFENBACHER S, SCHROEDER HE, SEYMOUR GJ, KORNMAN KS. Advances in the pathogenesis of periodontitis: summary of developments, clinical implications and future directions. Periodontol 2000. 1997;14(1):216–48.
4. Hajishengallis G. Immuno-microbial pathogenesis of periodontitis: Keystones, pathobionts, and the host response. Trends Immunol. 2014 Jan 23;35(1):3–11.
5. Irwin CR, Myrillas TT. The role of IL-6 in the pathogenesis of periodontal disease. Oral Dis. 1998;4(1):43–7.
6. Graves DT, Li J, Cochran DL. Inflammation and Uncoupling as Mechanisms of Periodontal Bone Loss. J Dent Res. 2011 Feb;90(2):143–53.
7. Taubman MA, Valverde P, Han X, Kawai T. Immune Response: The Key to Bone Resorption in Periodontal Disease. J Periodontol. 2005 Nov 1;76(11–s):2033–41.
8. Anderson GB, Palmer JA, Bye FL, Smith BA, Caffesse RG. Effectiveness of Subgingival Scaling and Root Planing: Single Versus Multiple Episodes of Instrumentation. J Periodontol. 67(4):367–73.
9. Hägi TT, Laugisch O, Ivanovic A, Sculean A. Regenerative periodontal therapy. Quintessence Int (Berl). 2014 Mar;45(3):185–92.
10. Wang H-L, Boyapati L. “PASS” principles for predictable bone regeneration. Implant Dent. 2006 Mar;15(1):8–17.
11. Engler WO, Ramfjord SP, Hiniker JJ. Healing following simple gingivectomy. A tritiated thymidine radioautographic study. I. Epithelialization. J Periodontol. 1966;37(4):298–308.
12. Dahlin C, Linde A, Gottlow J, Nyman S. Healing of bone defects by guided tissue regeneration. Plast Reconstr Surg. 1988 May;81(5):672–6.
13. Nyman S, Lindhe J, Karring T, Rylander H. New attachment following surgical treatment of human periodontal disease. J Clin Periodontol. 1982 Jul;9(4):290–6.
14. Hynes K, Menicanin D, Gronthos S, Bartold PM. Clinical utility of stem cells for periodontal regeneration. Periodontol 2000. 2012;59(1):203–27.
15. Gottlow J, Nyman S, Karring T, Lindhe J. New attachment formation as the result of controlled tissue regeneration. J Clin Periodontol. 1984 Sep;11(8):494–503.
16. Cortellini P, Pini Prato G, Tonetti MS. Periodontal regeneration of human infrabony defects. II. Re-entry procedures and bone measures. J Periodontol. 1993 Apr;64(4):261–8.
17. Reynolds MA, Aichelmann-Reidy ME, Branch-Mays GL, Gunsolley JC. The efficacy of bone replacement grafts in the treatment of periodontal osseous defects. A systematic review. Ann Periodontol. 2003 Dec;8(1):227–65.
18. Ramseier CA, Rasperini G, Batia S, Giannobile W V. Advanced regenerative technologies for periodontal tissue repair. Vol. 59, Periodontology 2000. 2012. p. 185–202.
19. Albrektsson T, Johansson C. Osteoinduction, osteoconduction and osseointegration. Eur spine J Off Publ Eur Spine Soc Eur Spinal Deform Soc Eur Sect Cerv Spine Res Soc. 2001 Oct;10 Suppl 2:S96-101.



20. Rogers GF, Greene AK. Autogenous bone graft: basic science and clinical implications. *J Craniofac Surg*. 2012 Jan;23(1):323–7.
21. Benic GI, Hammerle CHF. Horizontal bone augmentation by means of guided bone regeneration. *Periodontol 2000*. 2014 Oct;66(1):13–40.
22. Wozney JM. The potential role of bone morphogenetic proteins in periodontal reconstruction. *J Periodontol*. 1995 Jun;66(6):506–10.
23. Needleman I, Tucker R, Giedrys - Leeper E, Worthington H. Guided tissue regeneration for periodontal intrabony defects – a Cochrane Systematic Review\*. *Periodontol 2000*. 2005;37(1):106–23.
24. Rios HF, Bashutski JD, McAllister BS, Murakami S, Cobb CM, Patricia Chun Y-H, et al. Emerging Regenerative Approaches for Periodontal Reconstruction: Practical Applications From the AAP Regeneration Workshop. *Clin Adv Periodontics*. 5(1):40–6.
25. Dimitriou R, Jones E, McGonagle D, Giannoudis P V. Bone regeneration: current concepts and future directions. *BMC Med*. 2011 May 31;9:66.
26. Qin Y, Wang L, Gao Z, Chen G, Zhang C. Bone marrow stromal/stem cell-derived extracellular vesicles regulate osteoblast activity and differentiation in vitro and promote bone regeneration in vivo. Vol. 6, *Scientific reports*. 2016.
27. DiMarino AM, Caplan AI, Bonfield TL. Mesenchymal Stem Cells in Tissue Repair. *Front Immunol*. 2013 Sep 4;4:201.
28. Konala VBR, Mamidi MK, Bhonde R, Das AK, Pochampally R, Pal R. The current landscape of the mesenchymal stromal cell secretome: A new paradigm for cell-free regeneration. *Cytotherapy*. 2016;18(1):13–24.
29. Hong HS, Lee J, Lee E, Kwon YS, Lee E, Ahn W, et al. A new role of substance P as an injury-inducible messenger for mobilization of CD29+ stromal-like cells. *Nat Med*. 2009 Mar 8;15:425.
30. Pittenger MF, Mackay AM, Beck SC, Jaiswal RK, Douglas R, Mosca JD, et al. Multilineage Potential of Adult Human Mesenchymal Stem Cells. *Science (80- )*. 1999;284(5411):143–7.
31. Yamada Y, Nakamura S, Ueda M, Ito K. Papilla regeneration by injectable stem cell therapy with regenerative medicine: long-term clinical prognosis. *J Tissue Eng Regen Med*. 2015 Mar;9(3):305–9.
32. Kaigler D, Avila-Ortiz G, Travan S, Taut AD, Padial-Molina M, Rudek I, et al. Bone Engineering of Maxillary Sinus Bone Deficiencies Using Enriched CD90+ Stem Cell Therapy: A Randomized Clinical Trial. *J Bone Miner Res*. 2015 Jul;30(7):1206–16.
33. Gjerde C, Mustafa K, Hellem S, Rojewski M, Gjengedal H, Yassin MA, et al. Cell therapy induced regeneration of severely atrophied mandibular bone in a clinical trial. *Stem Cell Res Ther*. 2018 Aug;9(1):213.
34. Raposo G, Stoorvogel W. Extracellular vesicles: exosomes, microvesicles, and friends. Vol. 200, *The journal of cell biology*. 2013. p. 373–83.
35. Colombo M, Raposo G, Théry C. Biogenesis, secretion, and intercellular interactions of exosomes and other extracellular vesicles. Vol. 30, *Annual review of cell and developmental biology*. 2014. p. 255–89.
36. Valadi H, Ekström K, Bossios A, Sjöstrand M, Lee JJ, O. JL. Exosome-mediated transfer of mRNAs and microRNAs is a novel mechanism of genetic exchange between cells. Vol. 9, *Nature cell biology*. 2007. p. 654–9.
37. Tkach M, Théry C. Communication by Extracellular Vesicles: Where We Are and Where We Need to Go. Vol. 164, *Cell*. 2016. p. 1226–32.
38. Zhang B, Yeo RW, Tan KH, Lim SK. Focus on Extracellular Vesicles: Therapeutic Potential of Stem Cell-Derived Extracellular Vesicles. Vol. 17, *International journal of molecular sciences*. 2016. p. 174.

39. Bátiz LF, Castro MA, Burgos P V, Velásquez ZD, Muñoz RI, Lafourcade CA, et al. Exosomes as Novel Regulators of Adult Neurogenic Niches. *Front Cell Neurosci.* 2016;9:501.
40. Yu B, Zhang X, Li X. Exosomes Derived from Mesenchymal Stem Cells. Vol. 15, *International Journal of Molecular Sciences* . 2014.
41. Tsao C-R, Liao M-F, Wang M, Cheng C-M, Chen C-H. Mesenchymal Stem Cell Derived Exosomes: A New Hope for the Treatment of Cardiovascular Disease? . *Acta Cardiol Sin.* 2014 Sep 20;30(5):395–400.
42. Anderson P, Ivanov P. tRNA fragments in human health and disease. Vol. 588, *FEBS letters.* 2014. p. 4297–304.
43. Liu S, Liu D, Chen C, Hamamura K, Moshaverinia A, Yang R, et al. MSC Transplantation Improves Osteopenia via Epigenetic Regulation of Notch Signaling in Lupus. Vol. 22, *Cell metabolism.* 2015. p. 606–18.
44. Qi X, Zhang J, Yuan H, Xu Z, Li Q, Niu X, et al. Exosomes Secreted by Human-Induced Pluripotent Stem Cell-Derived Mesenchymal Stem Cells Repair Critical-Sized Bone Defects through Enhanced Angiogenesis and Osteogenesis in Osteoporotic Rats. Vol. 12, *International journal of biological sciences.* 2016. p. 836–49.
45. Zhang J, Liu X, Li H, Chen C, Hu B, Niu X. Exosomes/tricalcium phosphate combination scaffolds can enhance bone regeneration by activating the PI3K/Akt signaling pathway. Vol. 7, *Stem cell research & therapy.* 2016.
46. Phinney DG, Giuseppe M Di, Njah J, Sala E, Shiva S, Croix CMS. Mesenchymal stem cells use extracellular vesicles to outsource mitophagy and shuttle microRNAs. Vol. 6, *Nature communications.* 2015.
47. Lee C, Mitsialis SA, Aslam M, Vitali SH, Vergadi E, Konstantinou G, et al. Exosomes mediate the cytoprotective action of mesenchymal stromal cells on hypoxia-induced pulmonary hypertension. Vol. 126, *Circulation : journal of the American Heart Association.* 2012. p. 2601–11.
48. Zhang B, Yin Y, Lai RC, Tan SS, Choo ABH, Lim SK. Mesenchymal stem cells secrete immunologically active exosomes. Vol. 23, *Stem cells and development.* 2014. p. 1233–44.
49. Rani S, Ryan AE, Griffin MD, Ritter T. Mesenchymal Stem Cell-derived Extracellular Vesicles: Toward Cell-free Therapeutic Applications. *Mol Ther.* 2015 May 14;23(5):812–23.
50. Sluijter JPG, Verhage V, Deddens JC, van den Akker F, Doevendans PA. Microvesicles and exosomes for intracardiac communication. *Cardiovasc Res.* 2014 May 1;102(2):302–11.
51. Gatti S, Bruno S, Deregibus MC, Sordi A, Cantaluppi V, Tetta C, et al. Microvesicles derived from human adult mesenchymal stem cells protect against ischaemia–reperfusion-induced acute and chronic kidney injury. *Nephrol Dial Transplant.* 2011 May 1;26(5):1474–83.
52. Tan CY, Lai RC, Wong W, Dan YY, Lim S-K, Ho HK. Mesenchymal stem cell-derived exosomes promote hepatic regeneration in drug-induced liver injury models. *Stem Cell Res Ther.* 2014 Jun 10;5(3):76.
53. Keam S, Hutvagner G, Keam SP, Hutvagner G. tRNA-Derived Fragments (tRFs): Emerging New Roles for an Ancient RNA in the Regulation of Gene Expression. *Life.* 2015 Nov 27;5(4):1638–51.
54. They C, Amigorena S, Raposo G, Clayton A. Isolation and characterization of exosomes from cell culture supernatants and biological fluids. *Curr Protoc cell Biol.* 2006 Apr;Chapter 3:Unit 3.22.
55. Peng H, Shi J, Zhang Y, Zhang H, Liao S, Li W, et al. A novel class of tRNA-derived small RNAs extremely enriched in mature mouse sperm. *Cell Res.*

- 2012 Nov 9;22(11):1609–12.
56. Lin Z, McClure MJ, Zhao J, Ramey AN, Asmussen N, Hyzy SL, et al. MicroRNA Contents in Matrix Vesicles Produced by Growth Plate Chondrocytes are Cell Maturation Dependent. *Sci Rep.* 2018;8(1):3609.
  57. Lin Z, Rodriguez NE, Zhao J, Ramey AN, Hyzy SL, Boyan BD, et al. Selective enrichment of microRNAs in extracellular matrix vesicles produced by growth plate chondrocytes. *Bone.* 2016;88:47–55.